

LIBRA Tracker M

USER MANUAL

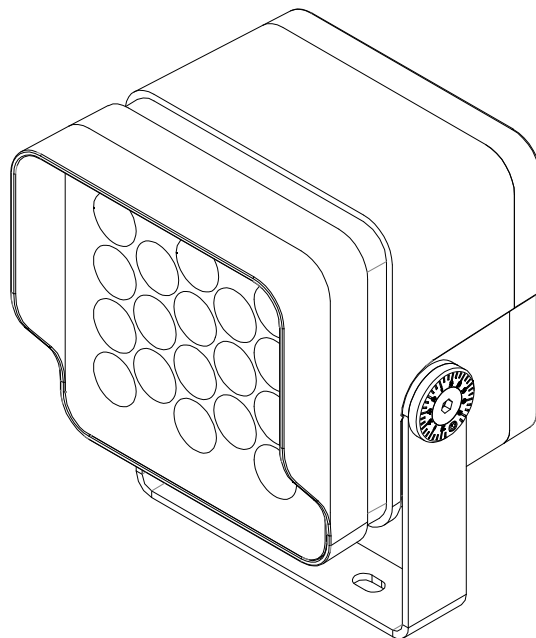

1. The luminaire shall be installed by a qualified electrician and wired in accordance with the latest IEE electrical regulations or the national requirements.
2. No supplied water-proof box, installation should be advised by qualified professional.
3. The external flexible cable can not be replaced. If the cable is damaged, the luminaire should be discarded.



IMG
L I G H T I N G

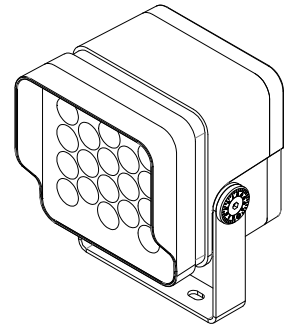
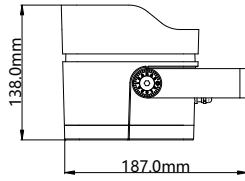
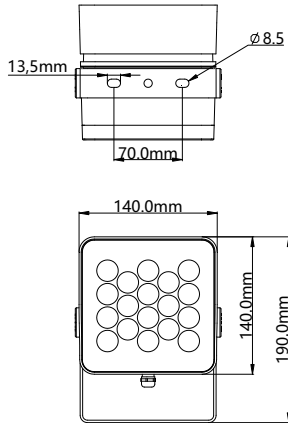

1

Torque 15N. M

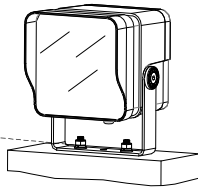
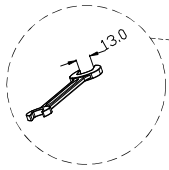

2

Torque 13N. M

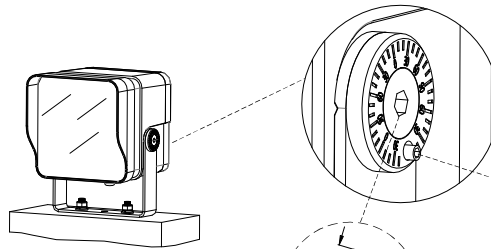
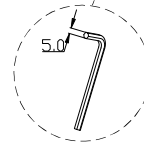

Torque 8N. M

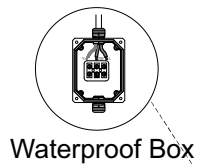
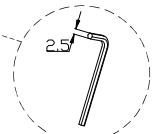

Waterproof Box

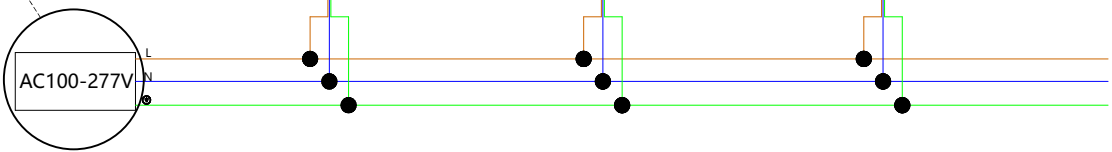

DMX

